

Feature

- Built-in bias resistors enable the configuration of an inverter circuit without connecting external input resistors (see equivalent circuit).
- The bias resistors consist of thin-film resistors with complete isolation to allow negative biasing of the input. They also have the advantage of almost completely eliminating parasitic effects.
- Only the on/off conditions need to be set for operation, making the device design easy.

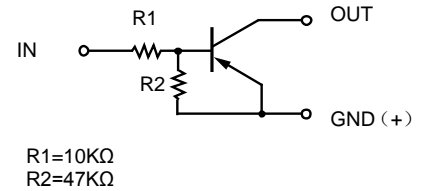

Applications

- Inverter
- Interface
- Driver

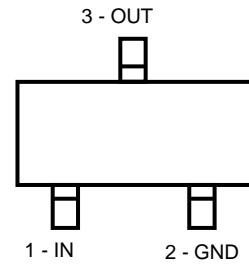

Top View

Mechanical Characteristics

- Lead finish:100% matte Sn(Tin)
- Mounting position: Any
- Qualified max reflow temperature:260°C
- Device meets MSL 1 requirements
- Pure tin plating: 7 ~ 17 um
- Pin flatness : ≤3mil

Structure

PNP epitaxial planar silicon transistor (Resistor built-in type)

Electrical characteristics per line@25°C (unless otherwise specified)

| Parameter | Symbol | Conditions | Min. | Typ. | Max. | Units |
|----------------------|--------------|----------------------------------|------|------|-------|-------|
| Input voltage | $V_{I(off)}$ | $V_{CC}=-5V, I_O=-100\mu A$ | - | - | -0.3 | V |
| | $V_{I(on)}$ | $V_O=-0.3V, I_O=-1mA$ | -1.4 | - | - | V |
| Output voltage | $V_{O(off)}$ | $I_O/I_I=-5mA/-0.25mA$ | - | -0.1 | -0.3 | V |
| Input current | I_I | $V_I=-5V$ | - | - | -0.88 | mA |
| Output current | $I_{O(off)}$ | $V_{CC}=-50V, V_I=0V$ | - | - | -0.5 | μA |
| DC current gain | G_1 | $V_O=-5V, I_O=-5mA$ | 68 | - | - | - |
| Input resistance | R_1 | - | 7 | 10 | 13 | KΩ |
| Resistance ration | R_2/R_1 | - | 3.7 | 4.7 | 5.7 | - |
| Transition frequency | f_T | $V_{CE}=-10V, I_E=5mA, f=100MHz$ | - | 250 | - | MHz |

Absolute maximum rating@25°C

| Rating | Symbol | Value | Units |
|----------------------|---------------|-------------|-------|
| Supply voltage | V_{CC} | -50 | V |
| Input voltage | V_{IN} | -40 to +6 | V |
| Output current | I_o | -70 | mA |
| | $I_{C(MAX.)}$ | -100 | mA |
| Power dissipation | P_d | 150 | mW |
| Junction temperature | T_j | 150 | °C |
| Storage temperature | T_{stg} | -55 to +150 | °C |

Typical Characteristics

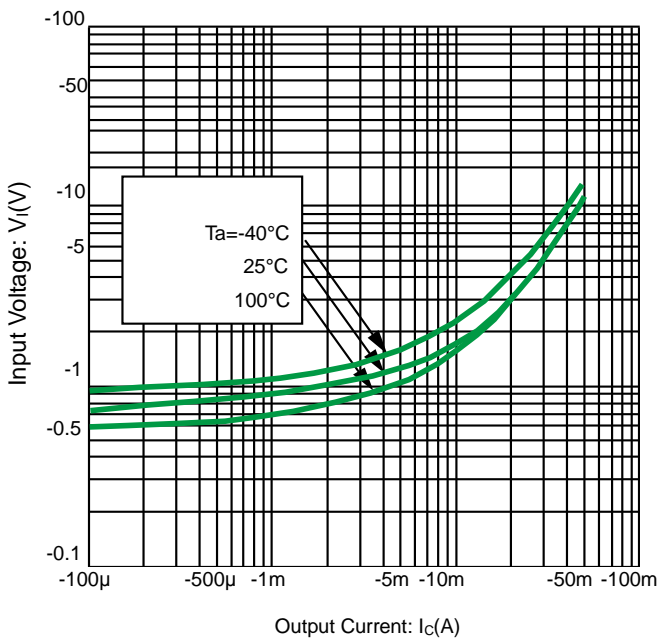

Fig 1. Input Voltage vs. output current
@ $V_C = -0.3V$ (ON characteristics)

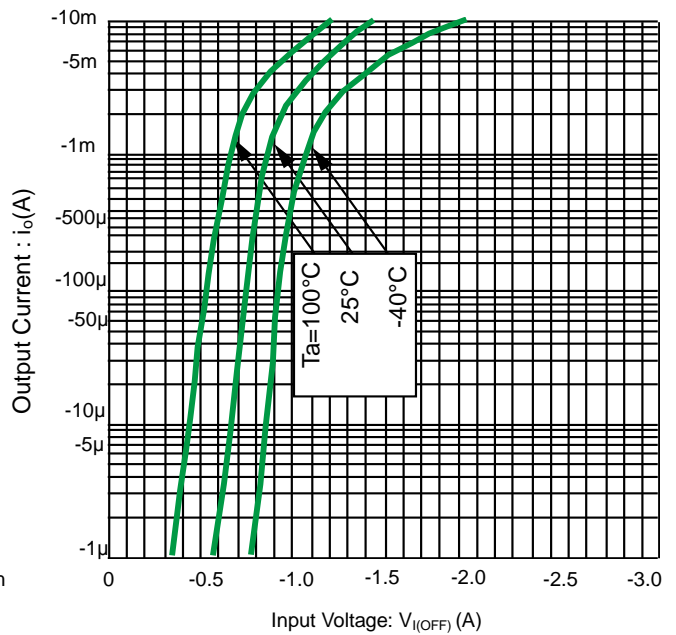
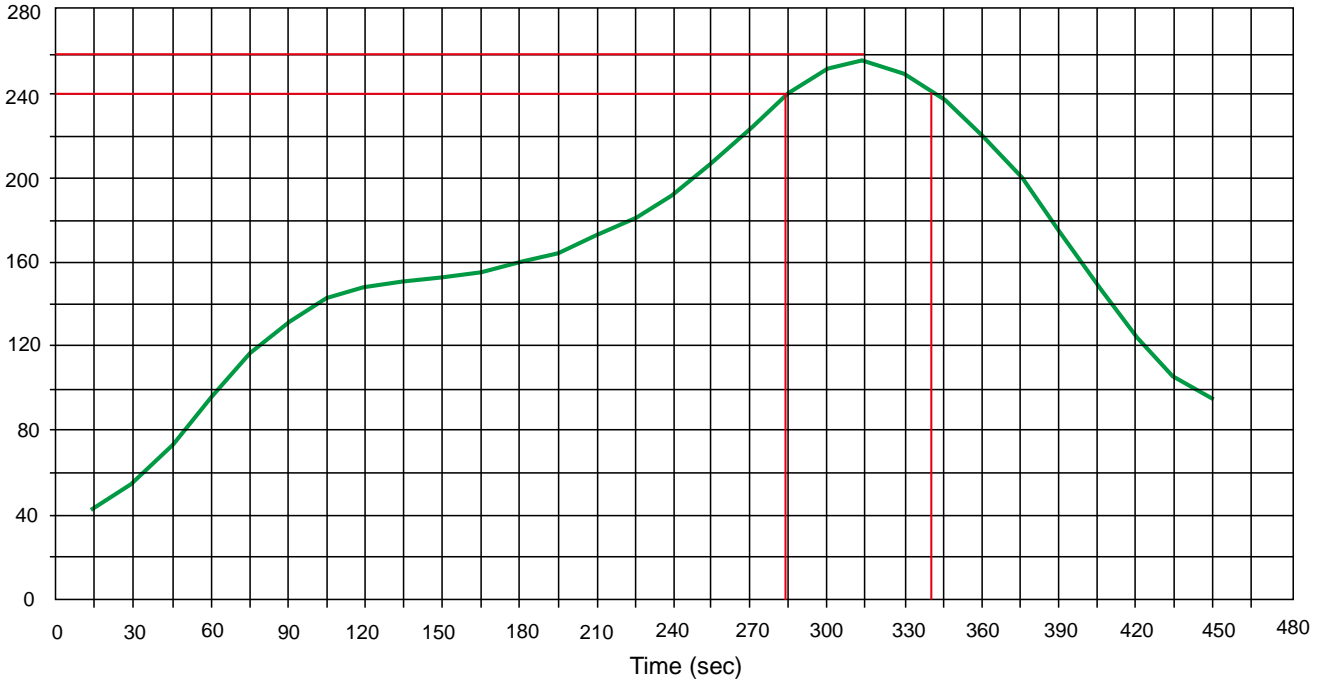

Fig 2. Output current vs. input voltage
@ $V_{CC} = -5V$ (OFF characteristics)

Solder Reflow Recommendation

Peak Temp=257°C, Ramp Rate=0.802deg. °C/sec



Product dimension (SOT-523)

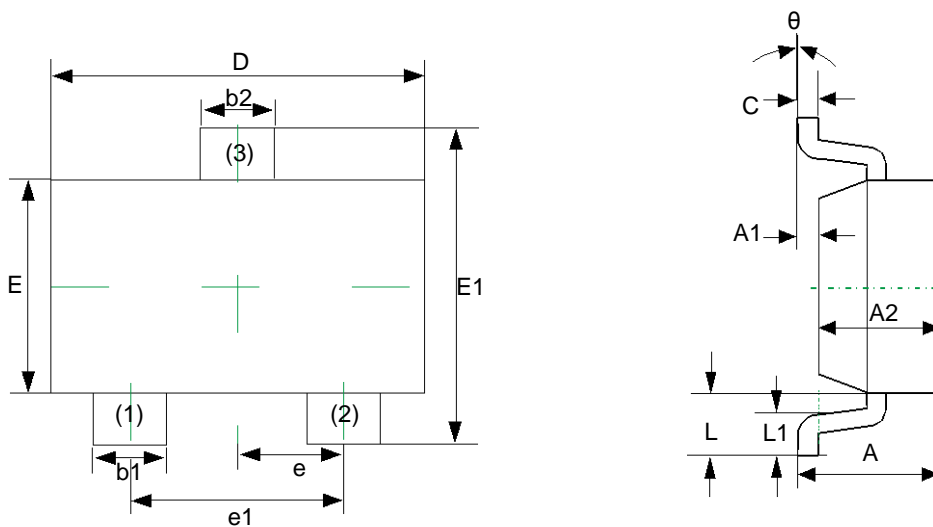

| Dim | Millimeters | | Inches | |
|----------|-------------|-------|----------|-------|
| | MIN | MAX | MIN | MAX |
| A | 0.700 | 0.900 | 0.028 | 0.035 |
| A1 | 0.000 | 0.100 | 0.000 | 0.004 |
| A2 | 0.700 | 0.800 | 0.028 | 0.031 |
| b1 | 0.150 | 0.250 | 0.006 | 0.010 |
| b2 | 0.250 | 0.350 | 0.010 | 0.014 |
| c | 0.100 | 0.200 | 0.004 | 0.008 |
| D | 1.500 | 1.700 | 0.059 | 0.067 |
| E | 0.700 | 0.900 | 0.028 | 0.035 |
| E1 | 1.450 | 1.750 | 0.057 | 0.069 |
| e | 0.500TYP | | 0.020TYP | |
| e1 | 0.900 | 1.100 | 0.035 | 0.043 |
| L | 0.400REF | | 0.016REF | |
| L1 | 0.260 | 0.460 | 0.010 | 0.018 |
| θ | 0° | | 8° | |

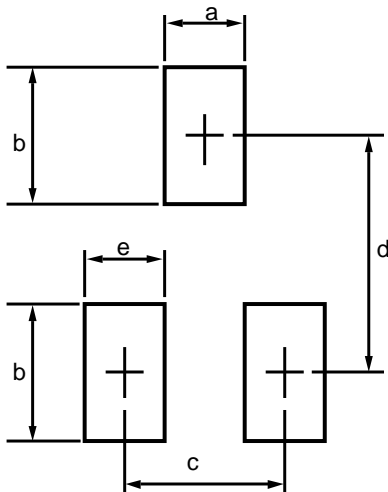

| Dim | Millimeters | |
|-----|-------------|------|
| | MIN | MAX |
| a | -- | 0.5 |
| b | -- | 0.6 |
| c | -- | 1.0 |
| d | -- | 1.24 |
| e | -- | 0.4 |

Ordering information

| Device | Package | Shipping |
|-----------|-------------------|--------------------|
| PDTA114YE | SOT-523 (Pb-Free) | 3000 / Tape & Reel |

IMPORTANT NOTICE

 and **Prisemi**[®] are registered trademarks of **Prisemi Electronics Co., Ltd (Prisemi)** ,Prisemi reserves the right to make changes without further notice to any products herein. Prisemi makes no warranty, representation or guarantee regarding the suitability of its products for any particular purpose, nor does Prisemi assume any liability arising out of the application or use of any product or circuit, and specifically disclaims any and all liability, including without limitation special, consequential or incidental damages. “Typical” parameters which may be provided in Prisemi data sheets and/or specifications can and do vary in different applications and actual performance may vary over time. All operating parameters, including “Typicals” must be validated for each customer application by customer’s technical experts. Prisemi does not convey any license under its patent rights nor the rights of others. The products listed in this document are designed to be used with ordinary electronic equipment or devices, Should you intend to use these products with equipment or devices which require an extremely high level of reliability and the malfunction of with would directly endanger human life (such as medical instruments, aerospace machinery, nuclear-reactor controllers, fuel controllers and other safety devices), please be sure to consult with our sales representative in advance.

Website: <http://www.prisemi.com>

For additional information, please contact your local Sales Representative.

©Copyright 2009, Prisemi Electronics

 **Prisemi**[®] is a registered trademark of Prisemi Electronics.

All rights are reserved.