

Surface Mount Superfast Recovery Rectifier

Feature

- Easy pick and place
- For surface mounted applications
- Low profile package
- Built-in strain relief
- Superfast recovery times for high efficiency

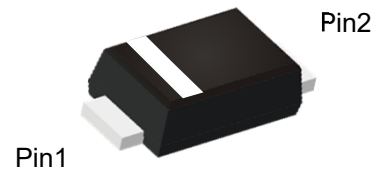

SOD-123FL(Top View)

Mechanical Characteristics

- Case: SOD-123FL
- Terminals: Solderable per MIL-STD-750, Method 2026
- Approx. Weight:15mg 0.00053oz

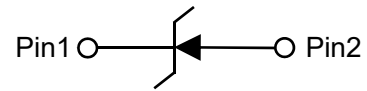

Circuit Diagram

Maximum Ratings and Electrical characteristics

Ratings at 25°C ambient temperature unless otherwise specified. Single phase, half wave, 60 Hz, resistive or inductive load. For capacitive load, derate current by 20%.

Parameter	Symbol	PES1 AW	PES1 BW	PES1 CW	PES1 DW	PES1 EW	PES1 GW	PES1 JW	Units
Maximum Repetitive Peak Reverse Voltage	V_{RRM}	50	100	150	200	300	400	600	V
Maximum RMS voltage	V_{RMS}	35	70	105	140	210	280	420	V
Maximum DC blocking voltage	V_{DC}	50	100	150	200	300	400	600	V
Maximum Average Forward Rectified Current at $T_C=125^\circ\text{C}$	$I_{F(AV)}$	1.0							A
Peak Forward Surge Current 8.3 ms Single Half Sine Wave Superimposed on Rated Load	I_{FSM}	30							A
Maximum Forward Voltage at 1 A	V_F	1.0				1.25		1.68	V
Maximum DC Reverse Current at Rated DC Blocking Voltage	$T_a=25^\circ\text{C}$	5.0							μA
	$T_a=125^\circ\text{C}$	100							
Typical Junction Capacitance at $V_R=4\text{V}, f=1\text{MHz}$	C_J	15							pF
Maximum Reverse Recovery Time ¹⁾	t_{rr}	35							ns
Typical Thermal Resistance ²⁾	$R_{\theta JA}$	85							$^\circ\text{C}/\text{W}$
Operating and Storage Temperature Range	T_J, T_{stg}	-55~+150							$^\circ\text{C}$

Notes:

- 1) Measured with $I_F = 0.5\text{ A}$, $I_R = 1\text{ A}$, $I_{rr} = 0.25\text{ A}$.
- 2) P.C.B. mounted with 2.0" X 2.0" (5 X 5 cm) copper pad areas.

Typical Characteristics

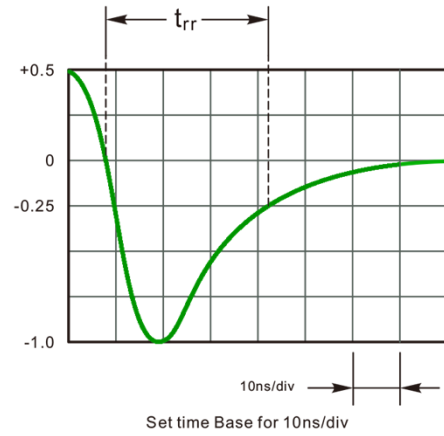
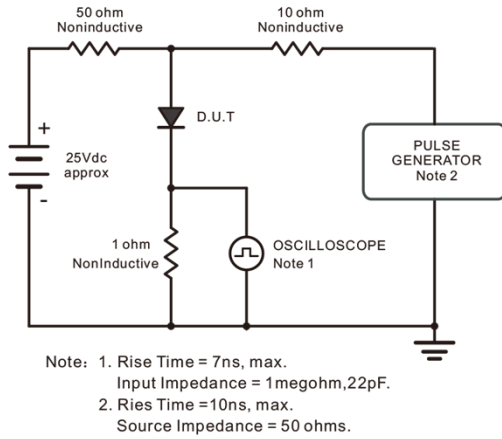

Fig.1 Reverse Recovery Time Characteristic And Test Circuit Diagram

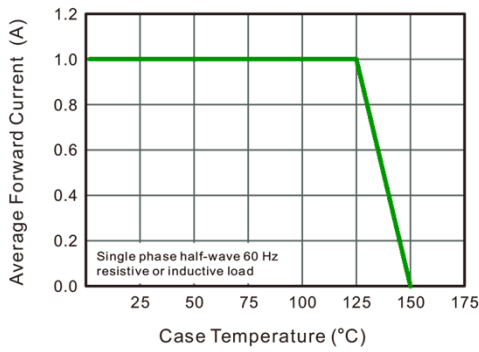

Fig.2 Maximum Average Forward Current Rating

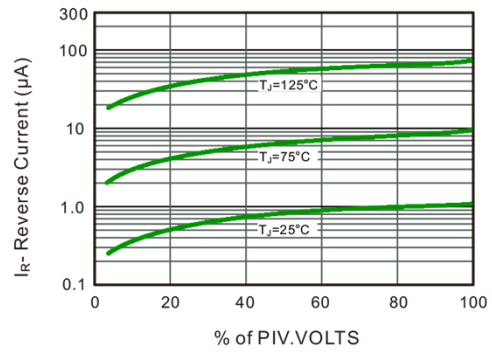

Fig.3 Typical Reverse Characteristics

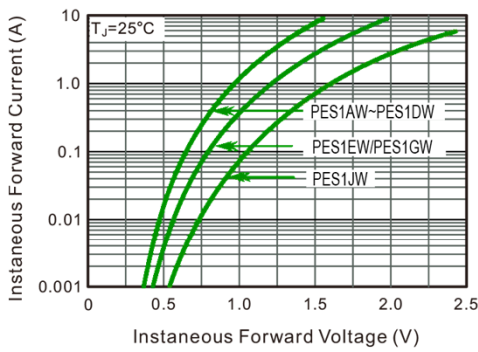

Fig.4 Typical Forward Characteristics

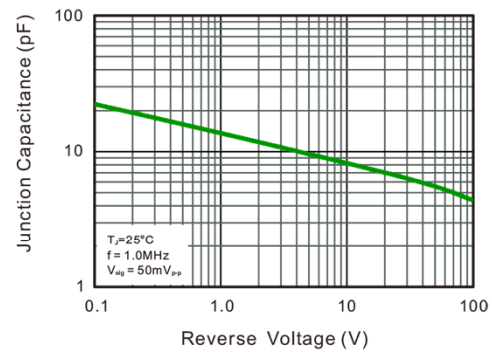

Fig.5 Typical Junction Capacitance

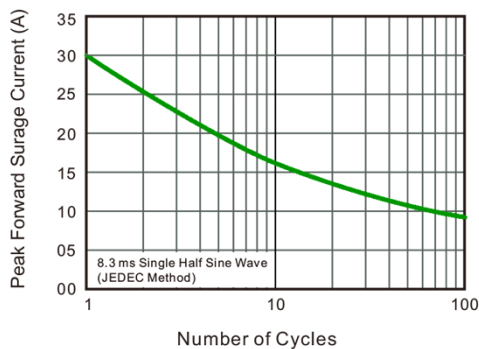
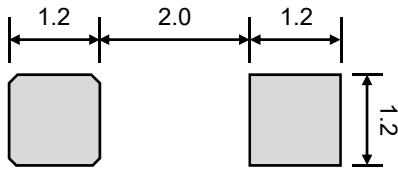
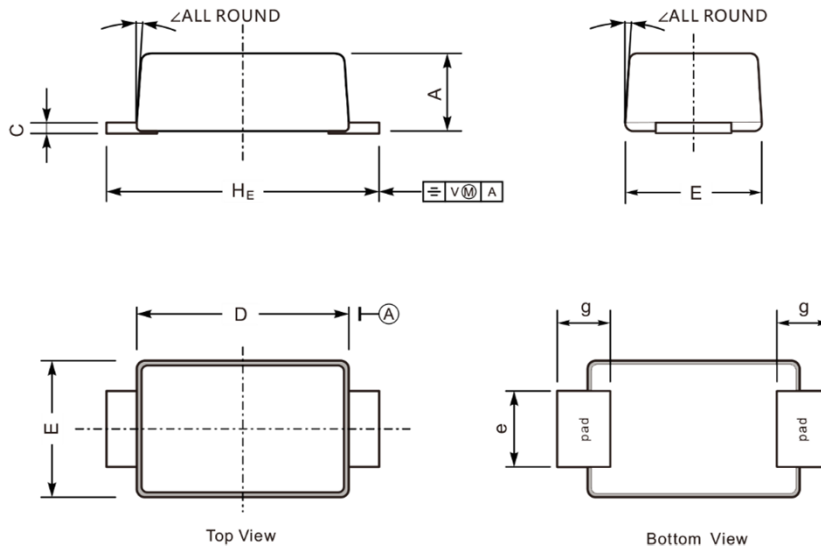

Fig.6 Maximum Non-Repetitive Peak Forward Surge Current

Surface Mount Superfast Recovery Rectifier

PES1AW~PES1JW

Product dimension (SOD-123FL)



Suggested PCB Layout

Unit:mm

Dim	Millimeters		Inches	
	Min	Max	Min	Max
A	0.90	1.10	0.035	0.043
C	0.12	0.20	0.005	0.008
D	2.60	2.90	0.102	0.114
E	1.70	1.90	0.067	0.075
e	0.80	1.10	0.031	0.043
g	0.70	0.90	0.028	0.035
H _E	3.50	3.80	0.138	0.150
\angle	7°			

Ordering information

Device	Package	Shipping
PES1AW~PES1JW	SOD-123FL (Pb-Free)	3000 / Tape & Reel

Marking information

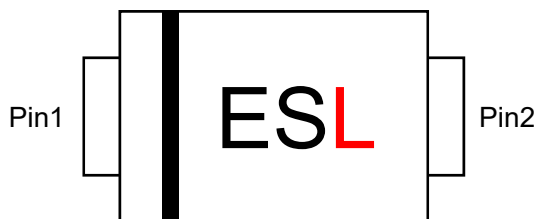

Device	Marking
PES1AW	ESL
PES1BW	
PES1CW	
PES1DW	
PES1EW	ESM
PES1GW	
PES1JW	ESH

Load with information

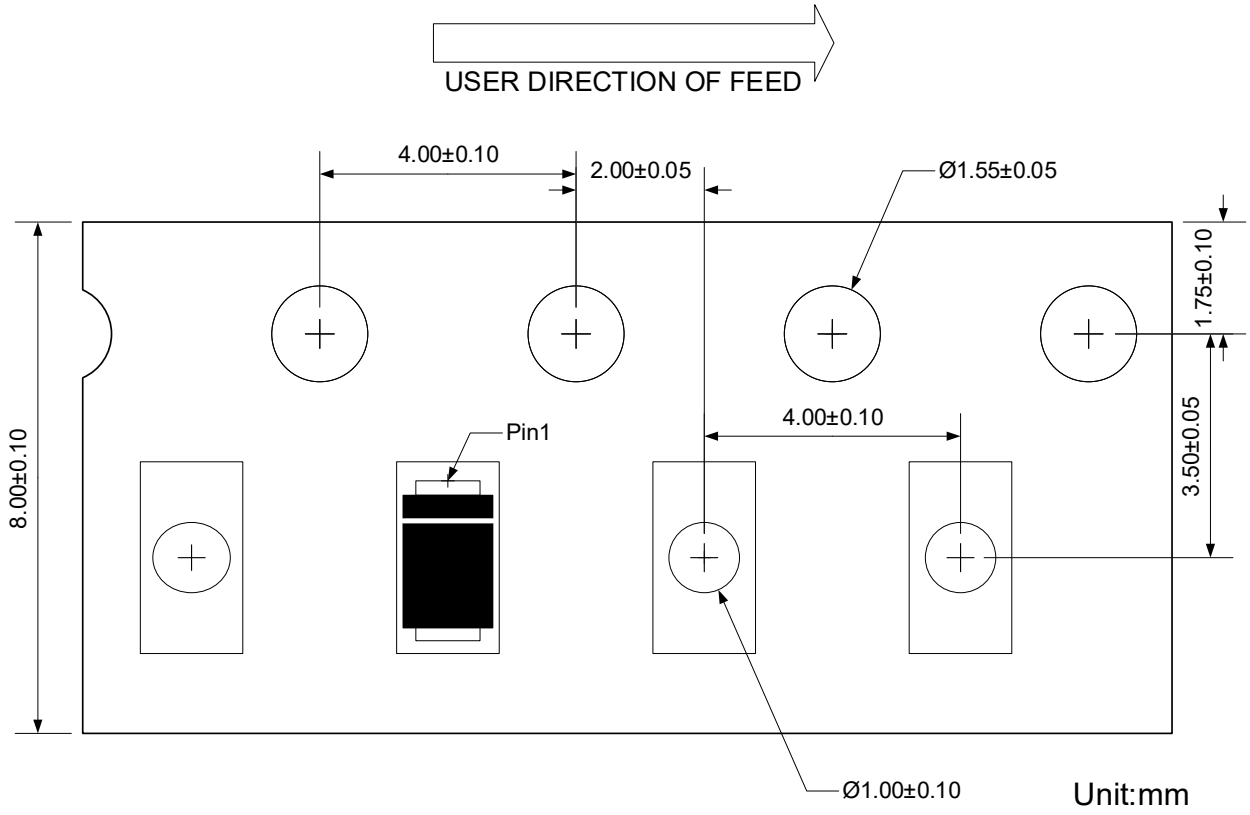

IMPORTANT NOTICE

 and **Prisemi**[®] are registered trademarks of **Prisemi Electronics Co., Ltd** (Prisemi), Prisemi reserves the right to make changes without further notice to any products herein. Prisemi makes no warranty, representation or guarantee regarding the suitability of its products for any particular purpose, nor does Prisemi assume any liability arising out of the application or use of any product or circuit, and specifically disclaims any and all liability, including without limitation special, consequential or incidental damages. “Typical” parameters which may be provided in Prisemi data sheets and/or specifications can and do vary in different applications and actual performance may vary over time. All operating parameters, including “Typicals” must be validated for each customer application by customer’s technical experts. Prisemi does not convey any license under its patent rights nor the rights of others. The products listed in this document are designed to be used with ordinary electronic equipment or devices, Should you intend to use these products with equipment or devices which require an extremely high level of reliability and the malfunction of with would directly endanger human life (such as medical instruments, aerospace machinery, nuclear-reactor controllers, fuel controllers and other safety devices), please be sure to consult with our sales representative in advance.

Website: <http://www.prisemi.com>

For additional information, please contact your local Sales Representative.

©Copyright 2009, Prisemi Electronics

 **Prisemi**[®] is a registered trademark of Prisemi Electronics.

All rights are reserved.