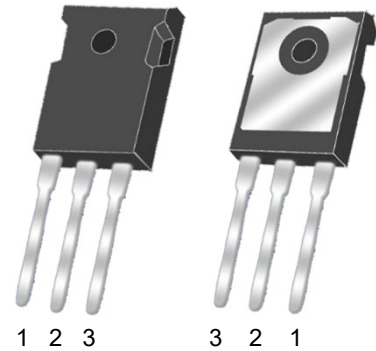
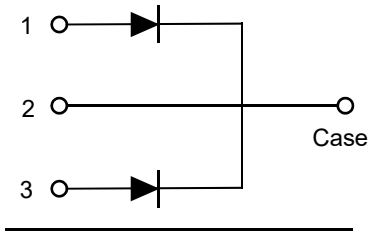

**Feature**

- Negligible reverse recovery
- Positive Temperature Coefficient
- Temperature-Independent Switching
- Fast switching
- Pb-free / RoHS compliant
- Low switching loss
- Higher frequency
- Low heat dissipation requirements
- Reduce size and cost of the system
- High-reliability

**TO-247-3L**
**Applications**

- Solar inverters
- Uninterruptable power supplies
- Motor drives
- Power Factor Correction

**Circuit Diagram**
**Absolute maximum rating@25°C**

Parameter		Symbol	Value	Units
Repetitive Peak Reverse Voltage		$V_{RRM}$	650	V
Surge Peak Reverse Voltage		$V_{RSM}$	650	V
DC Peak Reverse Voltage		$V_R$	650	V
Continuous Forward Current	$T_c=25^\circ\text{C}$	$I_F$	38/76	A
	$T_c=135^\circ\text{C}$		19/38	
	$T_c=160^\circ\text{C}$		10/20	
Non-repetitive Forward Surge Current	$T_c=25^\circ\text{C}, t_p=10\text{ms}, \text{Half Sine Pulse}$	$I_{FSM}$	80	A
	$T_c=110^\circ\text{C}, t_p=10\text{ms}, \text{Half Sine Pulse}$		70	
Repetitive Peak Forward Surge Current	$T_c=25^\circ\text{C}, t_p=10\text{ms}, \text{Half Sine Pulse}$	$I_{FRM}$	45	A
	$T_c=110^\circ\text{C}, t_p=10\text{ms}, \text{Half Sine Pulse}$		27	
i <sup>2</sup> t Value	$T_c=25^\circ\text{C}, t_p=10\text{ms}$	$\int i^2 dt$	31.7	A <sup>2</sup> s
	$T_c=110^\circ\text{C}, t_p=10\text{ms}$		24.3	
Power Dissipation	$T_c=25^\circ\text{C}$	$P_{tot}$	116/332	W
	$T_c=110^\circ\text{C}$		50/100	
Operating Junction Range		$T_J$	-55~+175	°C
Storage Temperature Range		$T_{STG}$	-55~+150	°C

## Electrical characteristics per line@25°C (unless otherwise specified)

Parameter	Symbol	Conditions	Min.	Typ.	Max.	Units
Forward Voltage	$V_F$	$I_F = 10A, T_J=25^\circ C$	-	1.3	1.5	V
		$I_F = 10A, T_J=175^\circ C$	-	1.5	-	
Reverse Current	$I_R$	$V_R = 650V, T_J=25^\circ C$	-	-	50	$\mu A$
		$V_R = 650V, T_J=175^\circ C$	-	-	200	
Total Capacitive Charge	$Q_C$	$V_R = 400V$	-	27	-	nC
Total Capacitance	C	$V_R = 0V, f = 1MHz$	-	561	-	pF
		$V_R = 200V, f = 1MHz$	-	55	-	
		$V_R = 400V, f = 1MHz$	-	43	-	

## Thermal Characteristics

Parameter	Symbol	Min.	Typ.	Max.	Units
Thermal Resistance ( Junction to case )	$R_{\theta JC}$	-	1.29/0.65	-	$^\circ C/W$

## Typical Characteristics

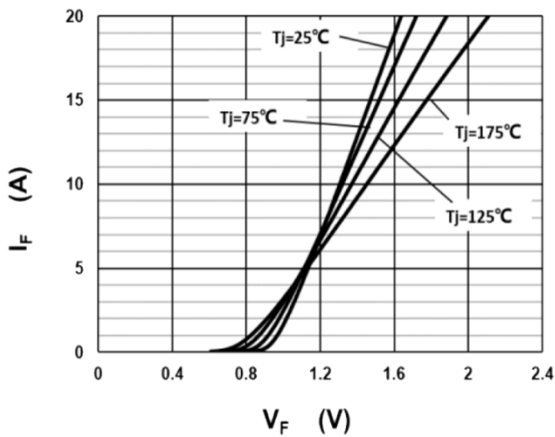

Fig.1 Forward Characteristics

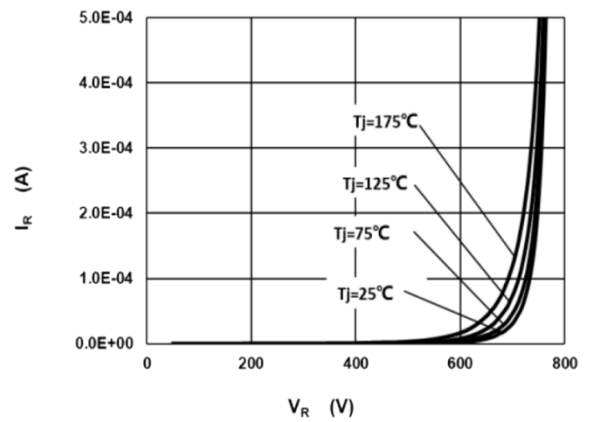

Fig.2 Reverse Characteristics

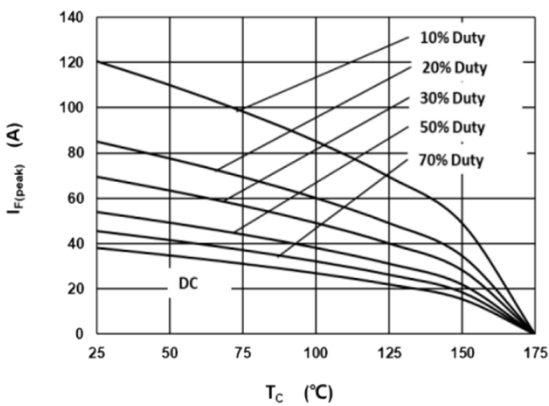

Fig.3 Current Derating

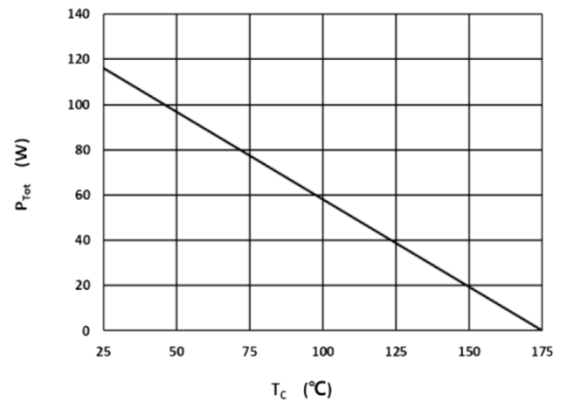

Fig.4 Power Derating

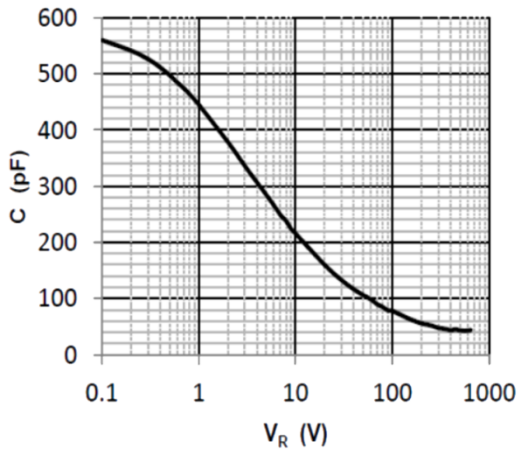

Fig.5 Capacitance vs. Reverse Voltage

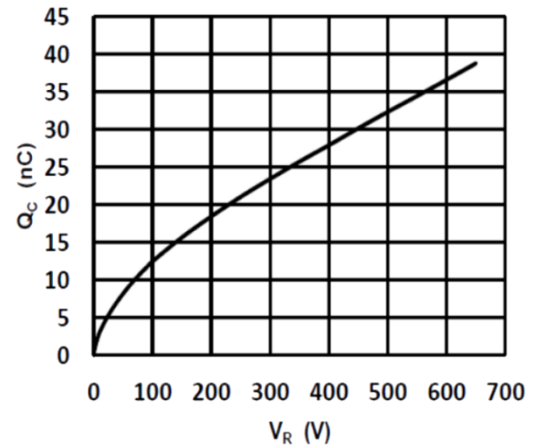

Fig.6 Capacitance Charge vs. Reverse Voltage

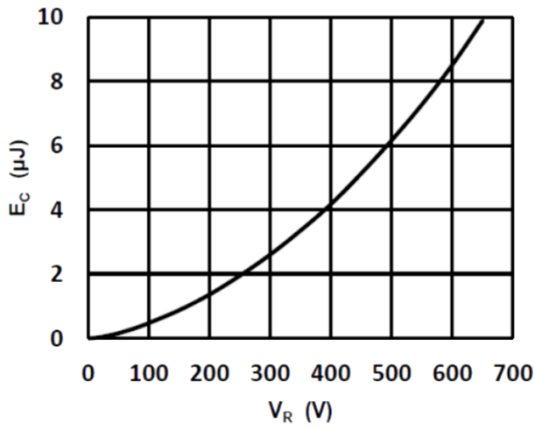

Fig.7 Capacitance Stored Energy

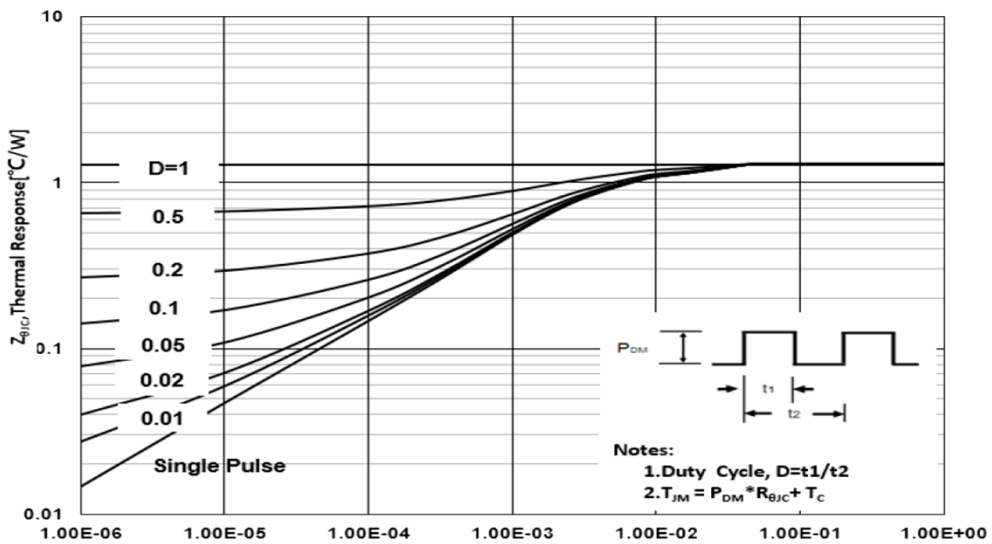
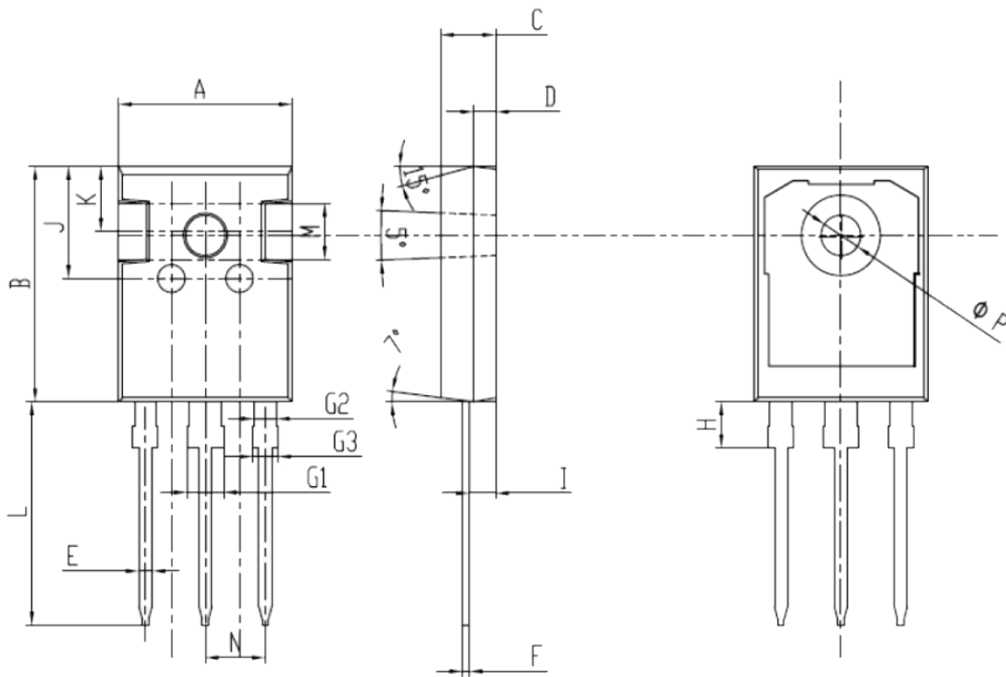



Fig.8 Transient Thermal Impedance

## Product dimension (TO-247-3L)



Dim	Millimeters		Inches	
	Min	Max	Min	Max
A	15.70	15.90	0.618	0.626
B	20.90	21.10	0.823	0.831
C	4.90	5.10	0.193	0.201
D	1.90	2.10	0.075	0.083
E	1.10	1.30	0.043	0.051
F	0.45	0.75	0.018	0.030
G1	3.00	3.20	0.118	0.126
G2	1.85	2.15	0.073	0.085
G3	2.00	2.20	0.079	0.087
H	4.00	4.30	0.157	0.169
I	2.30	2.50	0.091	0.098
J	9.90	10.10	0.390	0.398
K	5.70	5.90	0.224	0.232
L	19.80	20.20	0.780	0.795
M	4.85	5.15	0.191	0.203
N	5.286	5.586	0.208	0.220
φP	3.40	3.60	0.134	0.142

**IMPORTANT NOTICE**

 and **Prisemi**<sup>®</sup> are registered trademarks of **Prisemi Electronics Co., Ltd** (Prisemi), Prisemi reserves the right to make changes without further notice to any products herein. Prisemi makes no warranty, representation or guarantee regarding the suitability of its products for any particular purpose, nor does Prisemi assume any liability arising out of the application or use of any product or circuit, and specifically disclaims any and all liability, including without limitation special, consequential or incidental damages. "Typical" parameters which may be provided in Prisemi data sheets and/or specifications can and do vary in different applications and actual performance may vary over time. All operating parameters, including "Typicals" must be validated for each customer application by customer's technical experts. Prisemi does not convey any license under its patent rights nor the rights of others. The products listed in this document are designed to be used with ordinary electronic equipment or devices, Should you intend to use these products with equipment or devices which require an extremely high level of reliability and the malfunction of with would directly endanger human life (such as medical instruments, aerospace machinery, nuclear-reactor controllers, fuel controllers and other safety devices), please be sure to consult with our sales representative in advance.

Website: <http://www.prisemi.com>

For additional information, please contact your local Sales Representative.

©Copyright 2009, Prisemi Electronics

 **Prisemi**<sup>®</sup> is a registered trademark of Prisemi Electronics.

All rights are reserved.