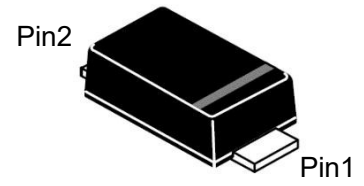
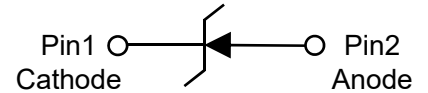
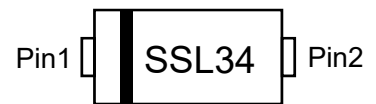

**Feature**

- Metal silicon junction, majority carrier conduction
- For surface mounted applications
- Low power loss, high efficiency
- High forward surge current capability
- For use in low voltage, high frequency inverters , free wheeling, and polarity protection applications

**SMAF(Top View)**

**Circuit Diagram**

**Marking (Top View)**
**Mechanical Characteristics**

- Case: SMAF
- Terminals: Solderable per MIL-STD-750, Method 2026
- Approx. Weight: 27mg / 0.00095oz

**Absolute maximum rating@25°C**

Rating	Symbol	Value	Units
Peak Repetitive Reverse Voltage	$V_{RRM}$	40	V
RMS Voltage	$V_{RMS}$	28	V
DC Blocking Voltage	$V_{DC}$	40	V
Average Forward Rectified Current	$I_{F(AV)}$	3.0	A
Peak Forward Surge Current 8.3 ms Single Half Sine Wave Superimposed on Rated Load	$I_{FSM}$	80	A
Forward Voltage at 3A	$V_F$	0.4	V
DC Reverse Current at Rated DC Blocking Voltage	$I_R$	$T_a=25^{\circ}C$	0.5
		$T_a=100^{\circ}C$	50
Typical Junction Capacitance <sup>1)</sup>	$C_J$	400	pF
Typical Thermal Resistance <sup>2)</sup>	$R_{\theta JA}$	100	°C/W
	$R_{\theta JL}$	30	
Operating Junction Temperature Range	$T_J$	-55 ~ +125	°C
Storage Temperature Range	$T_{STG}$	-55 ~ +150	°C

Notes:

1. Measured at 1 MHz and applied reverse voltage of 4 V D.C
2. P.C.B. mounted with 0.2" X 0.2" (5 X 5 mm) copper pad areas.

## Typical Characteristics

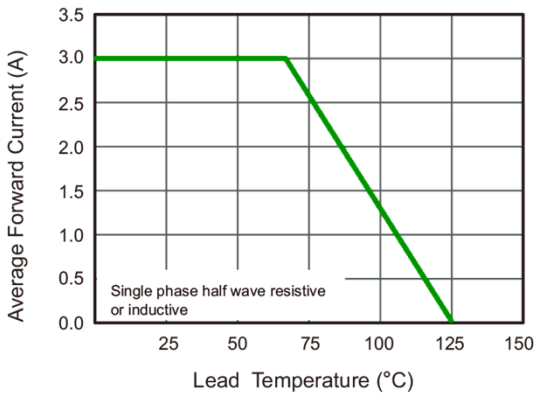

Fig.1 Forward Current Derating Curve

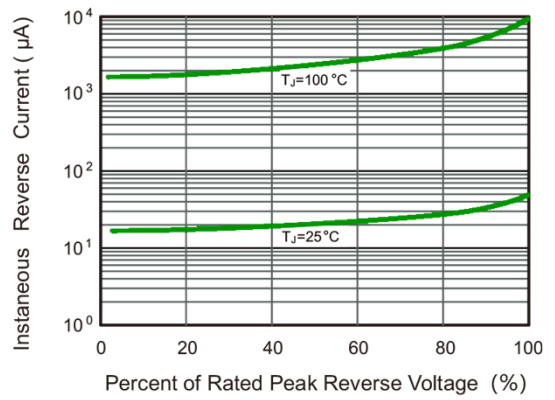

Fig.2 Typical Reverse Characteristics

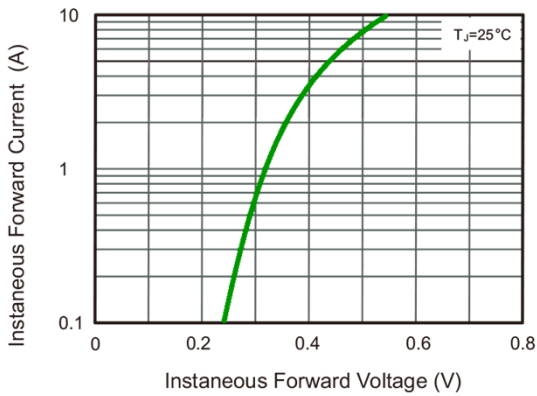

Fig.3 Typical Forward Characteristic

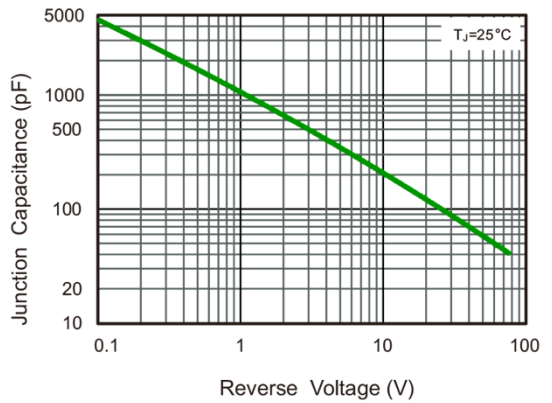

Fig.4 Typical Junction Capacitance

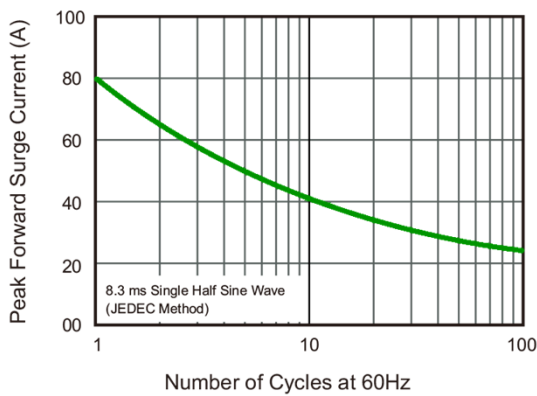
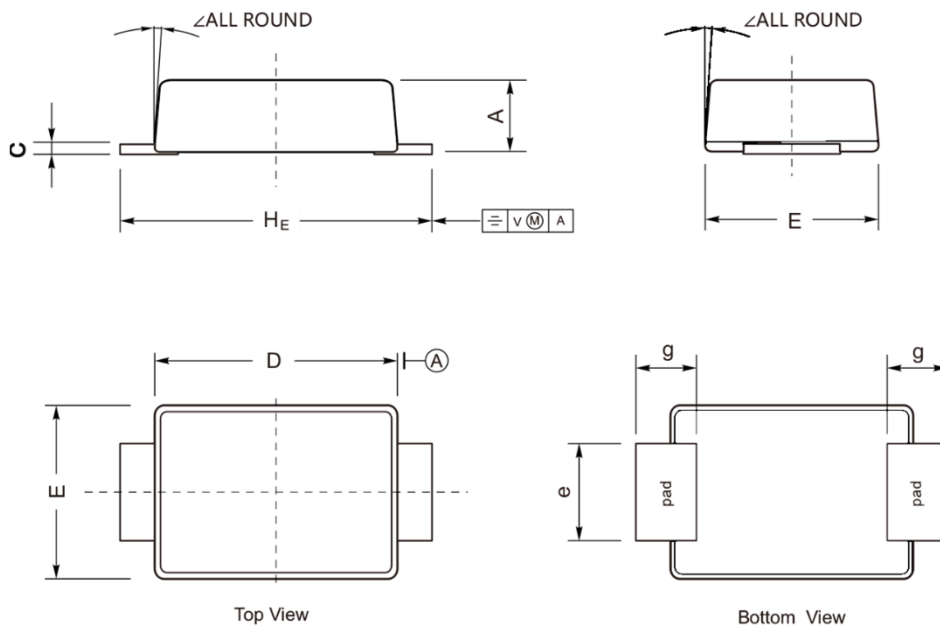
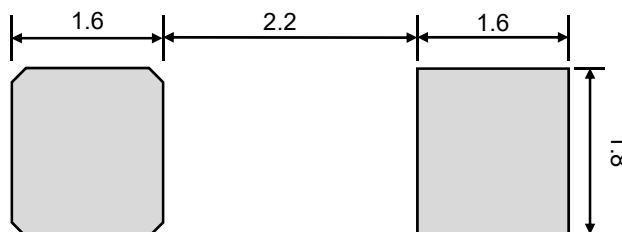

Fig.5 Maximum Non-Repetitive Peak Forward Surge Current

## Product Dimension (SMAF)



Dim	Millimeters		Inches	
	Min	Max	Min	Max
A	0.90	1.20	0.035	0.047
C	0.12	0.20	0.005	0.008
D	3.30	3.70	0.130	0.146
E	2.40	2.70	0.094	0.106
e	1.30	1.60	0.051	0.063
g	0.80	1.20	0.031	0.047
$H_E$	4.40	4.90	0.173	0.193
$\sphericalangle$	7°		7°	



Unit: mm

Suggested PCB Layout

# Schottky Barrier Diode

# PSBDAF40V3L

## Ordering information

Device	Package	Reel	Shipping
PSBDAF40V3L	SMAF	13"	3000 / Tape & Reel

## Load with information

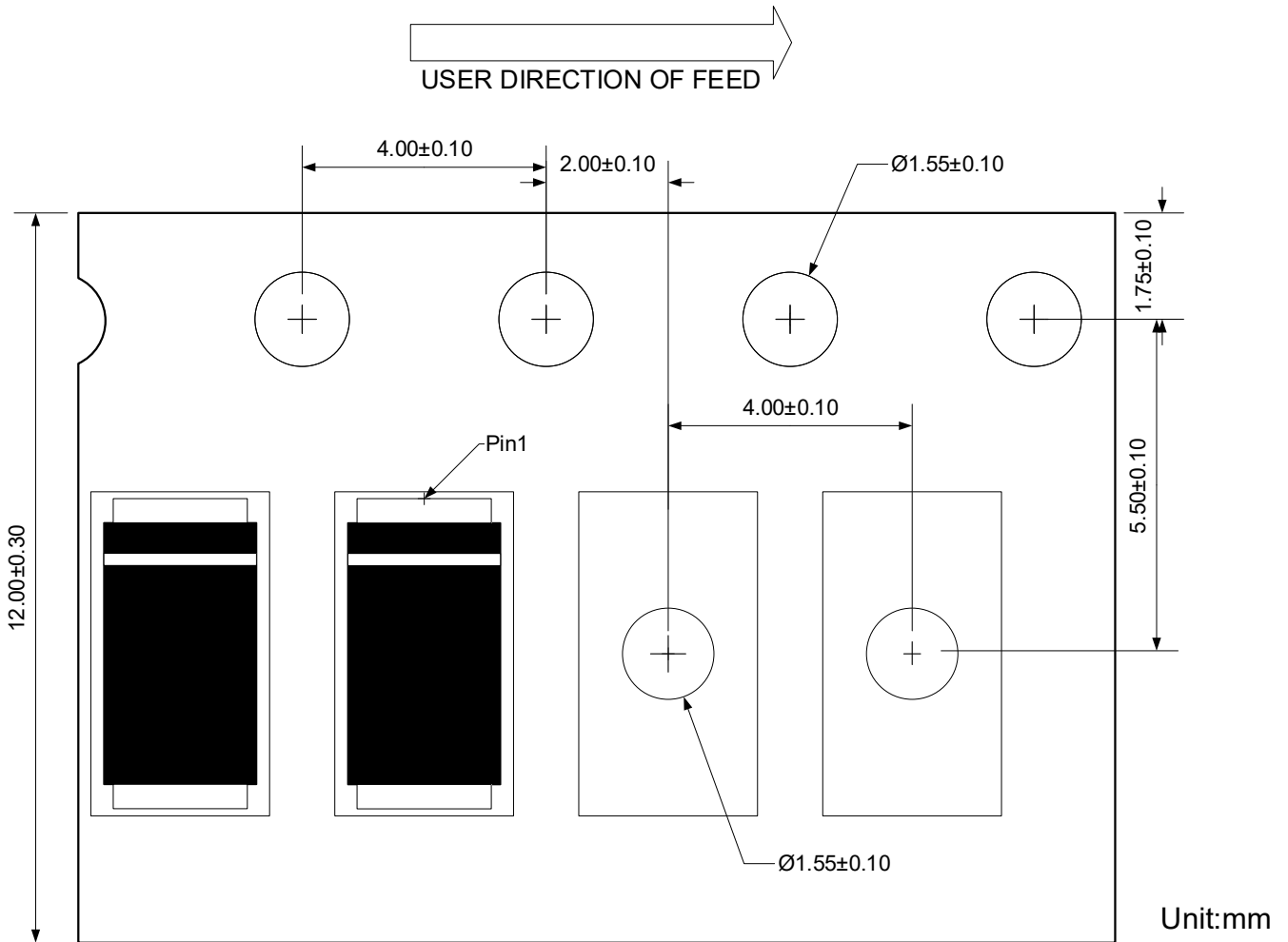

**IMPORTANT NOTICE**

 and **Prisemi**<sup>®</sup> are registered trademarks of **Prisemi Electronics Co., Ltd** (Prisemi), Prisemi reserves the right to make changes without further notice to any products herein. Prisemi makes no warranty, representation or guarantee regarding the suitability of its products for any particular purpose, nor does Prisemi assume any liability arising out of the application or use of any product or circuit, and specifically disclaims any and all liability, including without limitation special, consequential or incidental damages. "Typical" parameters which may be provided in Prisemi data sheets and/or specifications can and do vary in different applications and actual performance may vary over time. All operating parameters, including "Typicals" must be validated for each customer application by customer's technical experts. Prisemi does not convey any license under its patent rights nor the rights of others. The products listed in this document are designed to be used with ordinary electronic equipment or devices, Should you intend to use these products with equipment or devices which require an extremely high level of reliability and the malfunction of with would directly endanger human life (such as medical instruments, aerospace machinery, nuclear-reactor controllers, fuel controllers and other safety devices), please be sure to consult with our sales representative in advance.

Website: <http://www.prisemi.com>

For additional information, please contact your local Sales Representative.

©Copyright 2009, Prisemi Electronics

 **Prisemi**<sup>®</sup> is a registered trademark of Prisemi Electronics.

All rights are reserved.